



DATASHEET

VG10

v2.3

1. Datasheet

1.1. VG10

General Properties		Minimum	Typical	Maximum	Unit
Vacuum		5 %	-	80 %	[Vacuum]
		-0.05	-	-0.810	[Bar]
		1.5	-	24	[inHg]
Air flow		0	-	12	[L/min]
Arms adjustment		0	-	270	[°]
Arm holding torque		-	6	-	[Nm]
Payload	Rated	10			[kg]
		22			[lb]
	Maximum	15			[kg]
		33			[lb]
Vacuum cups		1	-	16	[pcs.]
Gripping time		-	0.35	-	[s]
Releasing time		-	0.20	-	[s]
Vacuum pump		Integrated, electric BLDC			
Arms		4, adjustable by hand			
Dust filters		Integrated 50µm, field replaceable			
IP Classification		IP54 *			
Dimensions (folded)		105 x 146 x 146			[mm]
		4.13 x 5.75 x 5.75			[inch]
Dimensions (unfolded)		105 x 390 x 390			[mm]
		4.13 x 15.35 x 15.35			[inch]
Weight		1.62			[kg]
		3.57			[lb]

* Do not use vacuum grippers in wet or damp conditions, particularly in CNC applications with moisture or cutting fluids. It can damage the gripper.

Operating Conditions	Minimum	Typical	Maximum	Unit
Power supply	20.4	24	28.8	[V]
Current consumption	50	600	1500	[mA]
Operating temperature (gripper and vacuum cups)	0	-	50	[°C]
	32	-	122	[°F]

Operating Conditions	Minimum	Typical	Maximum	Unit
Relative humidity (non-condensing)	0	-	95	[%]
Calculated operation life	30 000	-	-	[Hours]

Positioning the VG10 Arms and Channels

The arms can be folded to the preferred position simply by pulling in the arms. The torque needed to overcome the friction in the rotatable joints of the arm is high (6 N/m) to ensure that the arms do not move when handling 15 kg payloads.

The VG10 suction cups are grouped into two independent channels.

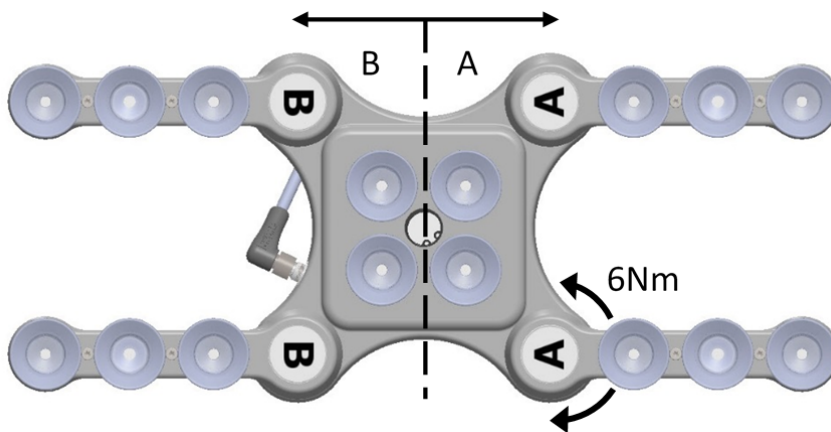

When the four arms are adjusted to preferred angles, it is recommended to add the accompanied arrow stickers. This allows for easy realignment and exchanging between different work items.



Payload



The lifting capacity of the VG grippers depends primarily on the following parameters:

- Vacuum cups
- Vacuum
- Air flow

Vacuum Cups

Choosing the right vacuum cups for your application is essential. The VG grippers come with common 15, 30 and 40 mm silicone vacuum cups (see table below) which are good for hard

and flat surfaces, but not good for uneven surfaces and it might leave microscopic traces of silicone on the workpiece which can cause issues with some types of painting processes afterwards.



Image	External Diameter [mm]	Internal Diameter [mm]	Gripping Area [mm ²]
	15	6	29
	30	16	200
	40	24	450

For non-porous materials, the OnRobot suction cups are highly recommended. Some of the most common non-porous materials are listed below:

- Composites
- Glass
- High density cardboard
- High density paper
- Metals
- Plastic
- Porous materials with a sealed surface
- Varnished wood

In an ideal case, working with non-porous material workpieces where there are no air flow going through the workpiece, the table below shows the number of cups and the cup size needed depending on the payload (workpiece mass) and the vacuum used.

Number of Cups needed for non-porous materials depending on payload and vacuum :

	 15 mm				 30 mm				 40 mm			
Payload (kg)	Vacuum (kPa)				Vacuum (kPa)				Vacuum (kPa)			
	20	40	60	75	20	40	60	75	20	40	60	75
0.1	3	2	1	1	1	1	1	1	1	1	1	1
0.5	13	7	5	4	2	1	1	1	1	1	1	1
1	-	13	9	7	4	2	2	1	2	1	1	1
2	-	-	-	14	8	4	3	2	4	2	2	1
3	-	-	-	-	12	6	4	3	5	3	2	2
4	-	-	-	-	15	8	5	4	7	4	3	2
5	-	-	-	-	-	10	7	5	9	5	3	3
6	-	-	-	-	-	12	8	6	10	5	4	3
7	-	-	-	-	-	13	9	7	12	6	4	4
8	-	-	-	-	-	15	10	8	14	7	5	4
9	-	-	-	-	-	-	12	9	15	8	5	4
10	-	-	-	-	-	-	13	10	-	9	6	5
11	-	-	-	-	-	-	14	11	-	9	6	5
12	-	-	-	-	-	-	15	12	-	10	7	6
13	-	-	-	-	-	-	16	13	-	11	8	6
14	-	-	-	-	-	-	-	14	-	12	8	7
15	-	-	-	-	-	-	-	15	-	13	9	7



NOTE:

To use more than 7 (15mm), 4 (30mm) or 3 (40mm) vacuum cups with the VGC10 a customized adaptor plate is needed.

The table above is created with the following formula that equalizes the lifting force with the payload considering 1.5G of acceleration.

$$\text{Amount}_{\text{Cups}} * \text{Area}_{\text{Cup}}[\text{mm}] = 14700 \frac{\text{Payload} [\text{kg}]}{\text{Vacuum} [\text{kPa}]}$$

It is often a good idea to use more vacuum cups than needed, to accommodate for vibrations, leaks and other unexpected conditions. However, the more vacuum cups, the more air leakage (air flow) is expected and the more air is moved in a grip resulting in longer gripping times.

When using porous materials, the vacuum that can be achieved by using the OnRobot suction cups will depend on the material itself and will be between the range stated in the specifications. Some of the most common non-porous materials are listed below:

- Fabrics
- Foam
- Foam with open cells
- Low density cardboard
- Low density paper
- Perforated materials
- Untreated wood

See the table below with general recommendations, in case other suction cups are needed for specific materials.

Workpiece surface	Vacuum cup shape	Vacuum cup material
Hard and flat	Normal or dual lip	Silicone or NBR
Soft plastic or plastic bag	Special plastic bag type	Special plastic bag type
Hard but curved or uneven	Thin dual lip	Silicone or soft NBR
To be painted afterwards	Any type	NBR only
Varying heights	1.5 or more bevels	Any type



NOTE:

It is recommended to consult a vacuum cup specialist to find the optimal vacuum cup where the standard types are insufficient.

Suction Cups for Foil and Bags Ø25

This suction cup improves the vacuum gripper’s ability to pick and place workpieces with surface of foil, thin paper, and plastic bags during irregular and angular arm movement.

	 25 mm			
Number of Cups	1	2	3	4
Surface	kg			
Foil	0.83	1.07	1.43	1.57
Thin paper	1.08	1.71	2.23	3.21
Foil - round shape	1.28	2.32	3.32	4.25
Plastic bag	0.32	0.54	0.63	0.74

The vacuum cup is silicone rubber compliant with the USA Food and Drug Administration (FDA).

Using this vacuum cup reduces the wrinkles made on thin workpieces (film, vinyl, and so on)

during absorption: 

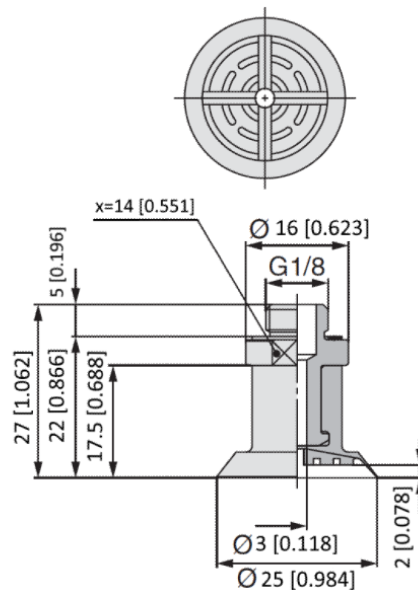

This vacuum cup is an accessory and need to be purchased separately. To purchase the vacuum cup, contact the vendor from where the VGx gripper has been purchased.

- Suction Cups for foil and bags Ø25 - PN 105922

Fittings and Blind Screws

It is possible to change suction cups simply by pulling them off the fittings. It might be a bit challenging to remove the 15 mm Diameter vacuum cups. As suggestion try to stretch the silicon to one of the sides and then pull it out.

Unused holes can be blinded using a blind screw, and each fitting can be changed to a different type to match the desired suction cup. The fittings and the blinding screws are mounted or dismounted by screwing (2Nm tightening torque) or unscrewing them with the provided 3 mm Allen key.

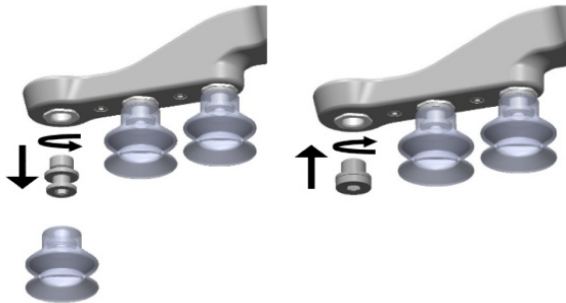

The thread size is the commonly used G1/8”; allowing for standard fittings, blinders and extenders to be fitted directly to the VG grippers.

Vacuum

Vacuum is defined as the percentage of absolute vacuum achieved relative to atmospheric pressure, i.e.:

% vacuum	Bar	kPa	inHg	Typically used for
0%	0.00rel.	0.00rel.	0.0rel.	No vacuum / No lifting capacity
	1.01 abs.	101.3 abs.	29.9 abs.	
20%	0.20rel.	20.3rel.	6.0rel.	Cardboard and thin plastics
	0.81 abs.	81.1 abs.	23.9 abs.	
40%	0.41rel.	40.5rel.	12.0rel.	Light workpieces and long suction cup life span
	0.61 abs.	60.8 abs.	18.0 abs.	
60%	0.61rel.	60.8rel.	18.0rel.	Heavy workpieces and strongly secured grips
	0.41 abs.	40.5 abs.	12.0 abs.	
80%	0.81rel.	81.1rel.	23.9rel.	Max. vacuum. Not recommended
	0.20 abs.	20.3 abs.	6.0 abs.	

The vacuum in kPa setting is the target vacuum. The pump will run at full speed until the target vacuum is achieved, and then run at a lower speed necessary to maintain the target vacuum.

The pressure in the atmosphere varies with weather, temperature and altitude. The VG grippers automatically compensate for altitudes up to 2km, where the pressure is about 80% of sea level.

Air Flow

Air flow is the amount of air that must be pumped to maintain the target vacuum. A completely tight system will not have any air flow, whereas real life applications have some smaller air leakages from two different sources:

- Leaking vacuum cup lips
- Leaking workpieces

The smallest leak under a vacuum cup can be hard to find (see picture below).

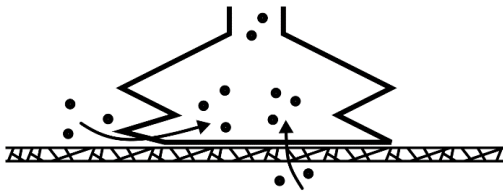

Leaking workpieces can be even harder to identify. Things that look completely tight might not be tight at all. A typical example is coarse cardboard boxes. The thin outer layer is often requiring a lot of air flow to create a pressure difference over it (see figure below).

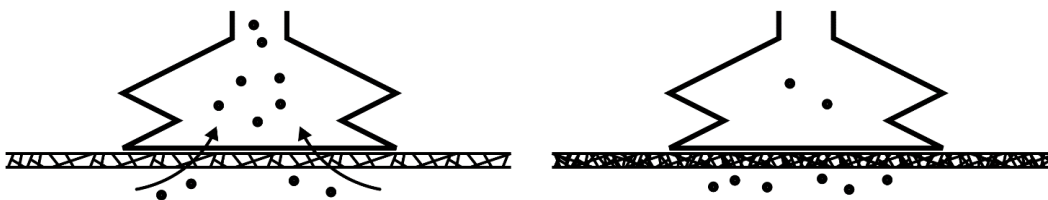

Therefore, the users must be aware of the following:

- VG grippers are not suitable for most uncoated, coarse cardboard boxes.
- Extra attention must be paid to leakages, e.g. vacuum cup shape and surface roughness

The air flow capability of a VG grippers is shown in the graph below:

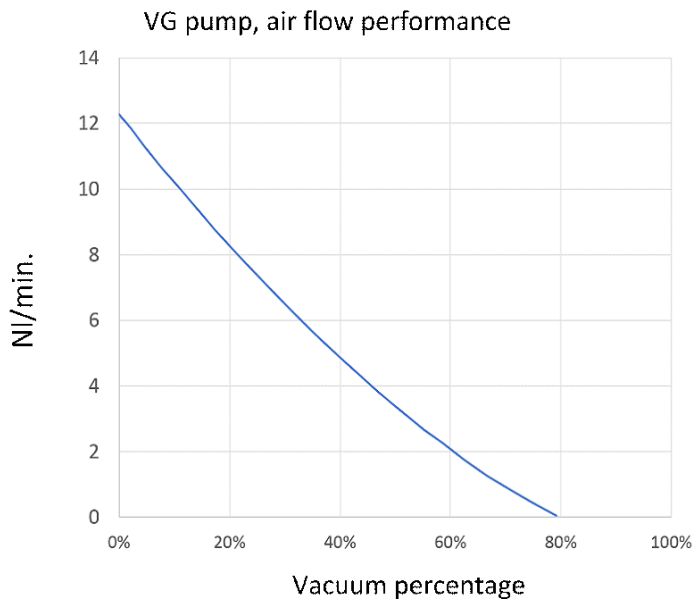



NOTE:

The easiest way to check if a cardboard box is sufficiently tight is simply to test it using the VG grippers.

A high vacuum percentage setting does not give a higher lifting capacity on corrugated cardboard. In fact, a lower setting is recommended, e.g. 20%.

A low vacuum setting results in less air flow and less friction below the vacuum cups. This means VG gripper filters and vacuum cups will last longer.

1.2. VG10 box content

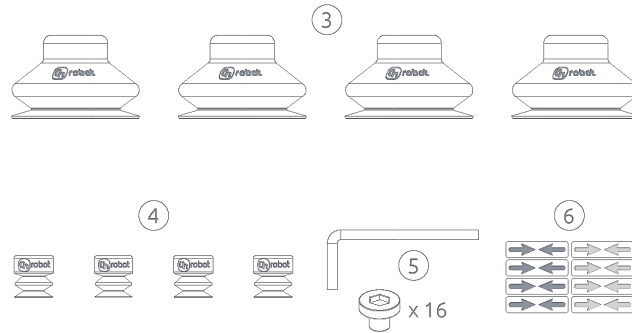
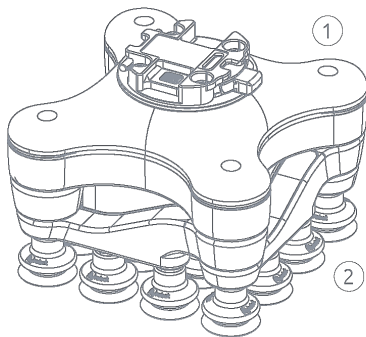

① VG10

② d30 mm Vacuum Cups*
*pre-mounted

③ d40 mm Vacuum Cups

④ d15 mm Vacuum Cups

⑤ Blind Screws and HEX 3mm Key

⑥ Positioning Arrows

1.3. VG10

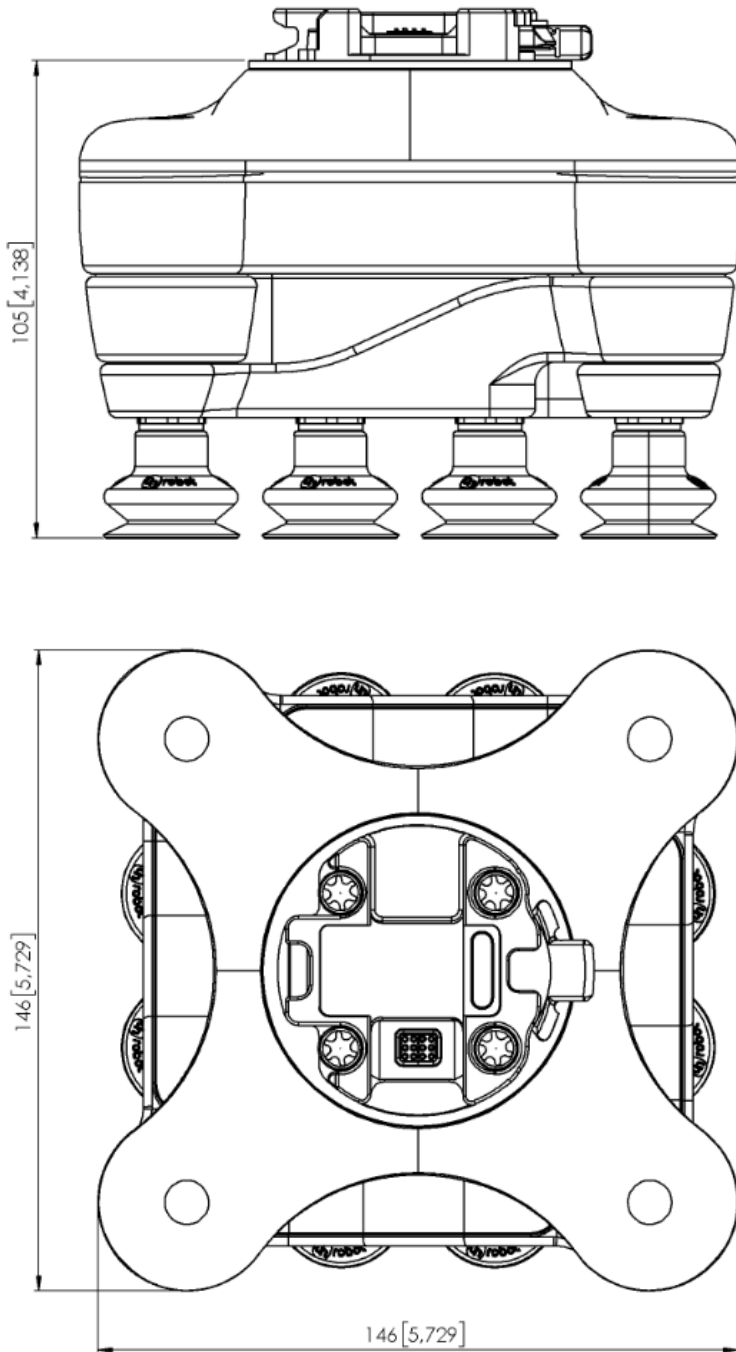

All dimensions are in mm and [inches].

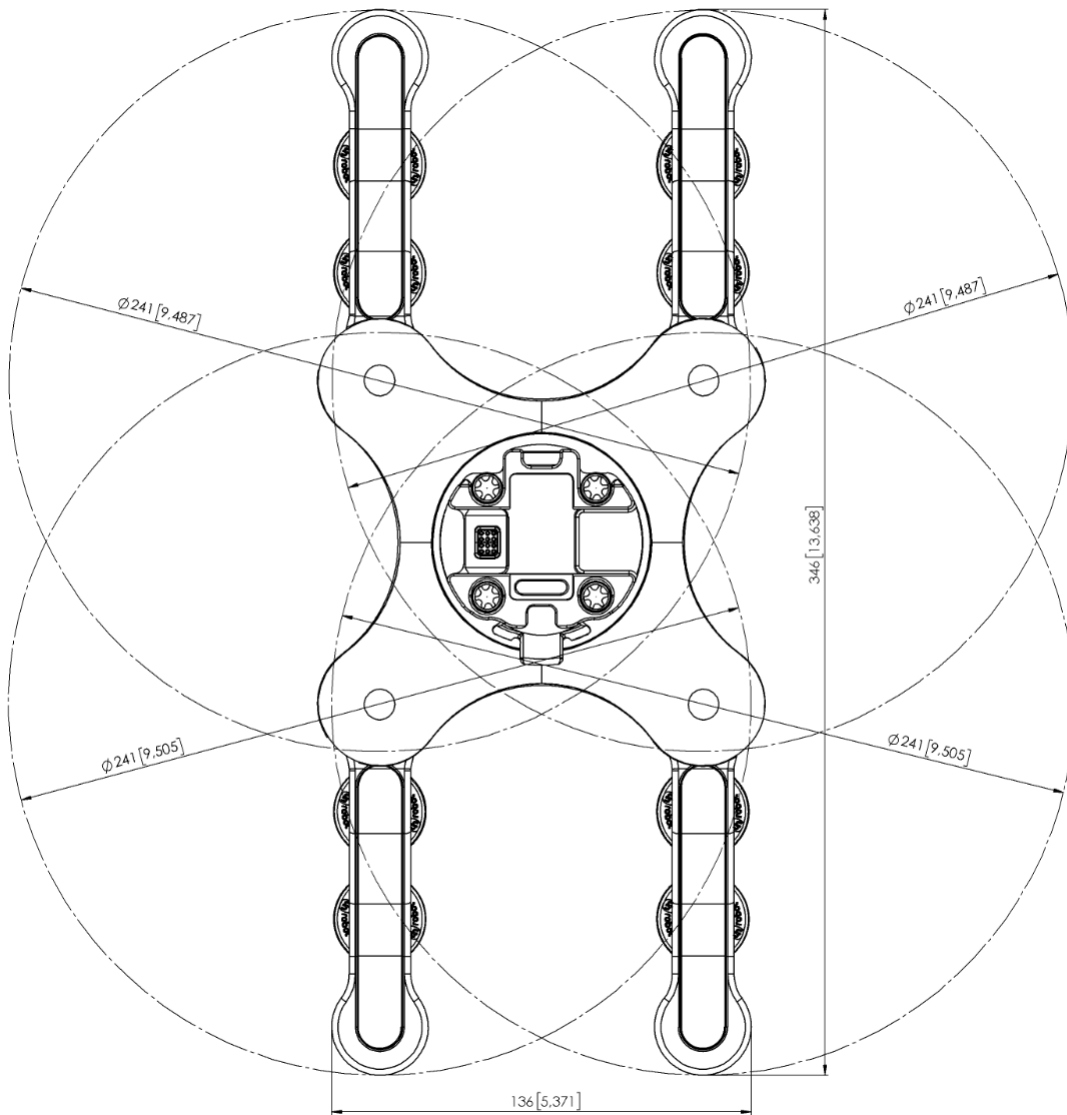

All dimensions are in mm and [inches].